

Data Sheet



Article number: 204260M1260A0S

Description: E+G levelling foot

GN 42-60-M12-60-A0-S

Note: S Without nut, External hexagon at the bottom

Measures

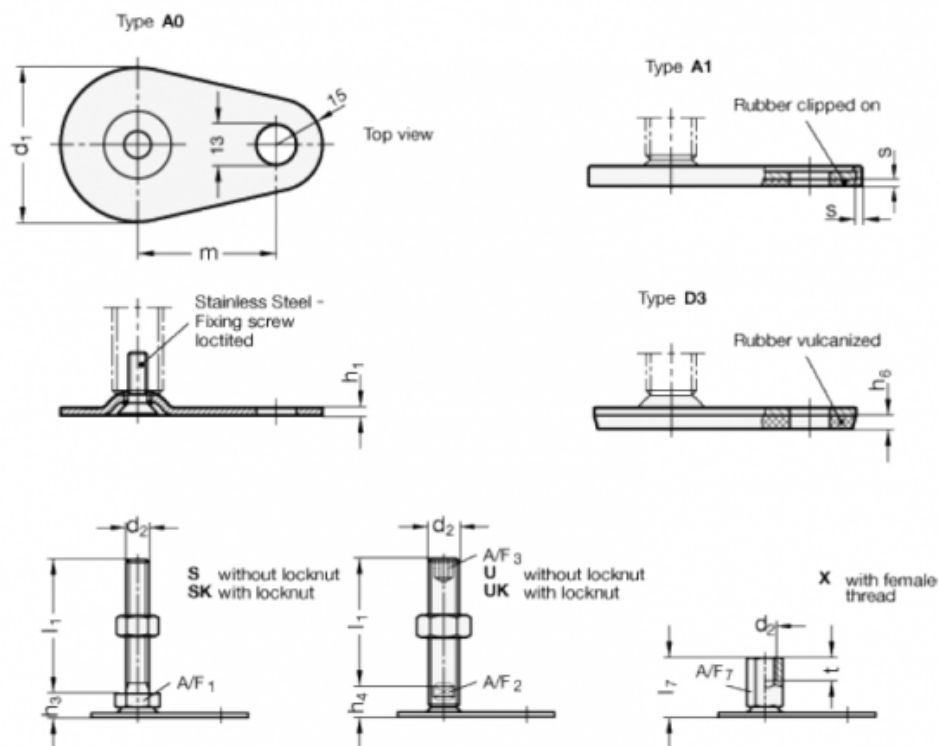

A/F1 = 17

d1 = 60

d2 = M12

h1 = 2.5

h3 = 11

h6 =

l1 = 60

m = 50

s =